



### Maximize AC Power Output

The high-performance MAC-800 dual unit microinverter is engineered for maximum AC power output when paired with Aptos Solar Technology's high-power solar panels. The MAC-800 is built for simple system integration and is compatible with third-party devices.

The MAC-800 is equipped and ready for system monitoring and trend tracking through Aptos Solar Technology's cloud based software.

In compliance with CA Rule 21 (UL 1741-SA), IEEE® 1547:2018 (UL 1741-SB 3rd Ed.)

### High-performance 2:1 Microinverter

Up to 800W



#### Maximum AC Power Output

- Up to 800W
- 10% more AC power output than competing products



#### Superior Long-term Reliability

- Industry leading 25-year warranty
- Over 2GW of microinverters deployed across 28 countries
- NEMA6 (IP67) enclosure rated for protection in harsh outdoor conditions



#### Streamlined Installation

- Separate trunk cables
- Compatible with 120 & 144 cell PV panels
- Battery integration ready



#### Built for Safety

- Built-in rapid shutdown feature in compliance with National Electrical Code (NEC)
- 6,000V surge protection feature

### Accessories



AC Trunk Cable,  
12/10 AWG Cable



AC Trunk Connector



AC Trunk Port Cap



AC Connector Cap - M



AC Trunk Port  
Disconnect Tool



DC Extension Cable



AC Trunk Connector  
Unlock Tool

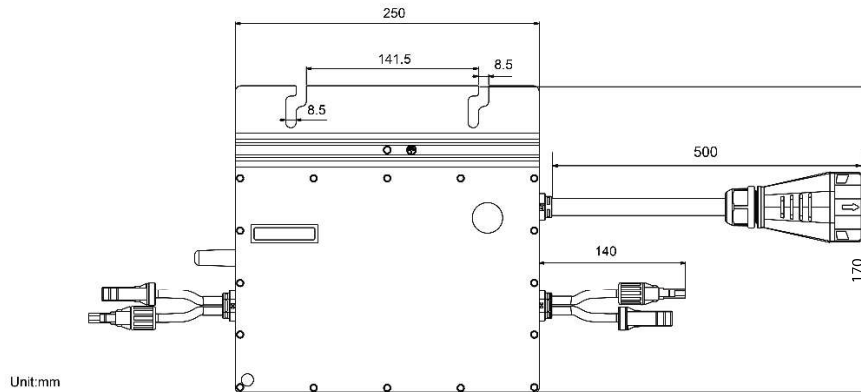

### Input Data (DC)

Commonly used module power (W)	320W-540W+
Maximum input voltage(V)	60
MPPT voltage range(V)	16-60
Start-up voltage(V)	22
Maximum input current $I_{sc}$ (A) <sup>1</sup>	2*15

### Mechanical Data

Ambient temperature range (°C)	-40 to +65
Dimensions (W X H X D mm)	250 X 170 X 28
Weight (kg)	2.6
Enclosure rating	Outdoor-NEMA (IP67)
Cooling	Natural convection - No fans

### Output Data (AC)

Peak output power(VA)	800	
Maximum continuous output power(VA)	766	
Maximum continuous output current (A)	3.19	3.68
Nominal output voltage/range(V) <sup>2</sup>	240/211-264	208/183-228
Nominal frequency/range (Hz) <sup>2</sup>	60/55-65	
Power factor (adjustable)	>0.99 default 0.8 leading...0.8 lagging	
Total harmonic distortion	<3%	
Maximum units per branch <sup>3</sup>	5/4	

### Efficiency

CEC peak efficiency	96.7%
CEC weighted efficiency	96.5%
Nominal MPPT efficiency	99.8%
Nighttime power consumption (mW)	<50

### Loading Quantity

Container	1X 20'GP	1X 40'GP/1X 40'HQ
Pallet No.	10	22
Carton No.	480	1008
Total quantity	2400	5040

### Features

Communication	2.4GHz Proprietary RF(Nordic)
Monitoring	AST Cloud <sup>4</sup>
Warranty	25 Years
Compliance	UL 1741, IEEE 1547, UL 1741 SA (240Vac), UL1741 SB (208Vac and 240Vac), CA Rule 21 (240Vac), CSA C22.2 No.107.1-16, FCC Part 15B, FCC Part 15C
PV Rapid Shutdown	Conforms with NEC-2017 and NEC-2020 Article 690.12 and CEC-2021 Sec 64-218 Rapid Shutdown of PV Systems

\*1 Maximum continuous input DC current is 12.5A

\*2 Nominal voltage/frequency range can be changed due to the requirements of local power department.

\*3 Refer to local requirements for exact number of microinverters per branch.

\*4 Aptos Monitoring System.